

**Driver LC 8W 180/200mA fixC SR SNC2**

essence series

**Product description**

- \_ Independent LED driver with cable clamps
- \_ Extra flat housing for constrained installation conditions (small ceiling cut outs and low ceiling voids)
- \_ For luminaires with M and MM as per EN 60598, VDE 0710 and VDE 0711
- \_ Temperature protection as per EN 61347-2-13 C5e
- \_ Output current 180 or 200 mA
- \_ Max. output power 8 W
- \_ Nominal lifetime up to 50,000 h
- \_ 5 years guarantee (Conditions at <https://www.tridonic.com/manufacturer-guarantee-conditions/>)

**Housing properties**

- \_ Casing: polycarbonate, white
- \_ Type of protection IP20
- \_ Push-in terminals
- \_ 2 separate strain relief parts for input and output cables with highly robust clamps

**Functions**

- \_ Overload protection
- \_ Short-circuit protection
- \_ No-load protection
- \_ No output current overshoot at mains on/off
- \_ Burst protection voltage 1 kV
- \_ Surge protection voltage 0.5 kV (L to N)
- \_ Surge protection voltage 1 kV (L/N to earth)

**Typical applications**

- \_ For spot light and downlight in retail and hospitality applications
- \_ For panel light and area light in office and education application

**Website**

<http://www.tridonic.com/87500799>



Spotlights



Downlights



Linear



Area



Floor | Wall



Free-standing



Street



Decorative



High bay

## Driver LC 8W 180/200mA fixC SR SNC2

essence series

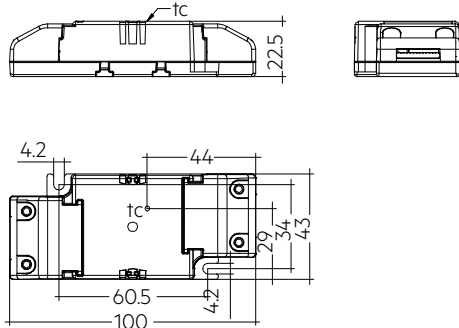

## Ordering data

Type	Article number	Packaging, carton	Packaging, low volume	Packaging, high volume	Weight per pc.
LC 8/180/44 fixC SR SNC2	87500799	39 pc(s).	819 pc(s).	5,733 pc(s).	0.052 kg
LC 8/200/40 fixC SR SNC2	87500800	39 pc(s).	819 pc(s).	5,733 pc(s).	0.052 kg

## Technical data

Rated supply voltage	220 – 240 V
AC voltage range	198 – 264 V
Mains frequency	50 / 60 Hz
Overvoltage protection	320 V AC, 1 h
THD (at 230 V, 50 Hz, full load)	≤ 120 %
Output current tolerance ①	± 7.5 %
Typical output LF current ripple at full load	± 5 %
Output P_ST_LM (at full load)	≤ 1
Output SVM (at full load)	≤ 0.4
Starting time (at 230 V, 50 Hz, full load)	≤ 0.5 s
Turn off time (at 230 V, 50 Hz, full load)	≤ 0.5 s
Hold on time at power failure	0 s
Ambient temperature $t_a$	-25 ... +50 °C
Ambient temperature $t_a$ (at lifetime 50,000 h)	40 °C
Storage temperature $t_s$	-40 ... +80 °C
Type of protection	IP20
Lifetime	up to 50,000 h
Guarantee (conditions at <a href="http://www.tridonic.com">www.tridonic.com</a> )	5 Year(s)
Dimensions L x W x H	100 x 43 x 22.5 mm

## Approval marks



## Standards

EN55015, EN 60598-1, EN 61000-3-2, EN 61000-3-3, EN 61347-1, EN 61347-2-13, EN 61547, EN 62384

## Specific technical data

Type	Output current ①	Input current (at 230 V, 50 Hz, full load)	Max. input power	Typ. power consumption $P_n$ (at 230 V, 50 Hz, full load)	Output power range	$\lambda$ at full load	Efficiency at full load ②	$\lambda$ over full operating range (min.)	Efficiency at min. load	Min. forward voltage	Max. forward voltage ③	Max. output voltage (U-OUT)	Max. peak output current ③	Max. casing temperature $t_c$
LC 8/180/44 fixC SR SNC2	180 mA	88 mA	10 W	9.5 W	5.4 – 7.9 W	0.50C	82 %	0.5C	80 %	30 V	44 V	100 V	205 mA	75 °C
LC 8/200/40 fixC SR SNC2	200 mA	78 mA	10 W	9.5 W	4.6 – 8.0 W	0.55C	82 %	0.5C	80 %	23 V	40 V	100 V	225 mA	75 °C

① Output current is mean value.

② Test result at 230 V, 50 Hz.

③ The trend between min. and full load is linear.

## 1. Standards

EN 55015  
 EN 61000-3-2  
 EN 61000-3-3  
 EN 61347-1  
 EN 61347-2-13  
 EN 61547  
 EN 60598-1  
 EN 62384

### 1.1 Glow wire test

according to EN 60598-1 with increased temperature of 850 °C passed.

## 2. Thermal details and lifetime

### 2.1 Expected lifetime

Expected lifetime			
Type	$t_a$	40 °C	50 °C
LC 8/180/44 fixC SR SNC2	$t_c$	65 °C	75 °C
	Lifetime	50,000 h	30,000 h
LC 8/200/40 fixC SR SNC2	$t_c$	65 °C	75 °C
	Lifetime	50,000 h	30,000 h

The LED drivers are designed for a lifetime stated above under reference conditions and with a failure probability of less than 10 %.

The relation of  $t_c$  to  $t_a$  temperature depends also on the luminaire design. If the measured  $t_c$  temperature is approx. 5 K below  $t_c$  max.,  $t_a$  temperature should be checked and eventually critical components (e.g. ELCAP) measured. Detailed information on request.

## 3. Installation / wiring

### 3.1 Circuit diagram

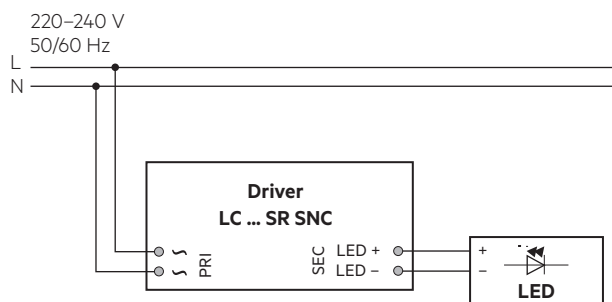

### 3.2 Wiring type and cross section

For wiring use stranded wire with ferrules or solid wire from 0.5–1.5 mm<sup>2</sup>. Strip 8.5–9.5 mm of insulation from the cables to ensure perfect operation of the push-wire terminals.  
 Use one wire for each terminal connector only.  
 The max. torque at the clamping screw (M3) is 0.3 Nm.

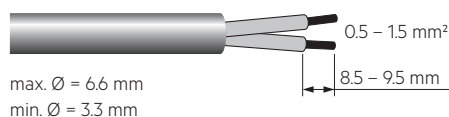

### 3.3 Release of the wiring

Press down the “push button” and remove the cable from front.

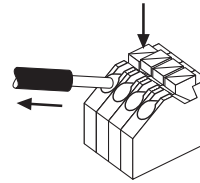

### 3.4 Fixing conditions when using as independent Driver with Clip-On

Dry, acidfree, oilfree, fatfree. It is not allowed to exceed the maximum ambient temperature ( $t_a$ ) stated on the device. Minimum distances stated below are recommendations and depend on the actual luminaire. Is not suitable for fixing in corner.

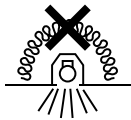
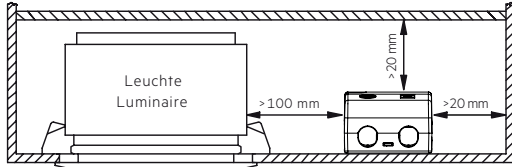

Device not suitable for covering with thermally insulating material

### 3.5 Wiring guidelines

- All connections must be kept as short as possible to ensure good EMI behaviour.
- Mains leads should be kept apart from LED driver and other leads (ideally 5 – 10 cm distance)
- Max. length of output wires is 2 m.
- To comply with the EMC regulations run the secondary wires (LED module) in parallel.
- Secondary switching is not permitted.
- Incorrect wiring can damage LED modules.
- To avoid the damage of the Driver, the wiring must be protected against short circuits to earth (sharp edged metal parts, metal cable clips, louver, etc.).

### 3.6 Replace LED module

1. Mains off
2. Remove LED module
3. Wait for 10 seconds
4. Connect LED module again

Hot plug-in or secondary switching of LEDs is not permitted and may cause a very high current to the LEDs.

### 3.7 Installation instructions

The LED module and all contact points within the wiring must be sufficiently insulated against 3 kV surge voltage.  
Air and creepage distance must be maintained.

### 3.8 Mounting of device

Max. torque for fixing: 0.5 Nm/M4

#### 4. Electrical values

##### 4.1 Diagrams LC 8W 180mA fixC SR SNC2

4.1.1 Efficiency vs load

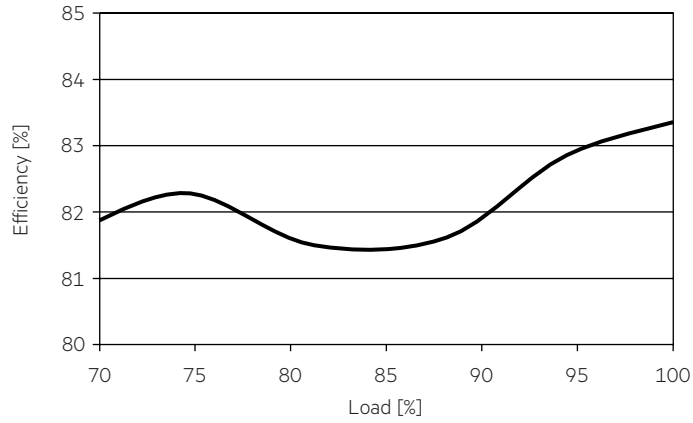

4.1.4 Input current vs load

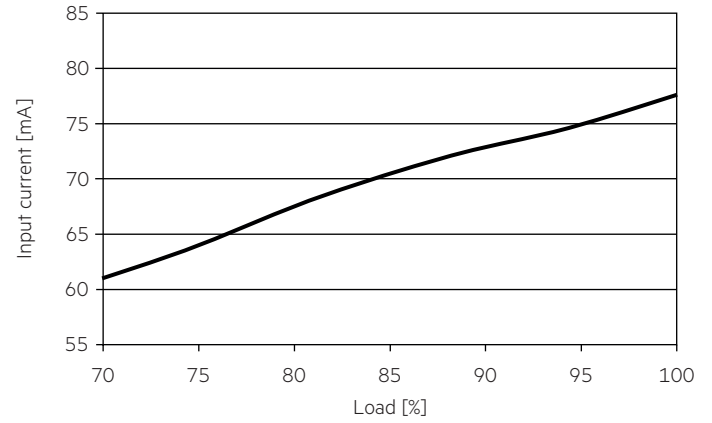

4.1.2 Power factor vs load

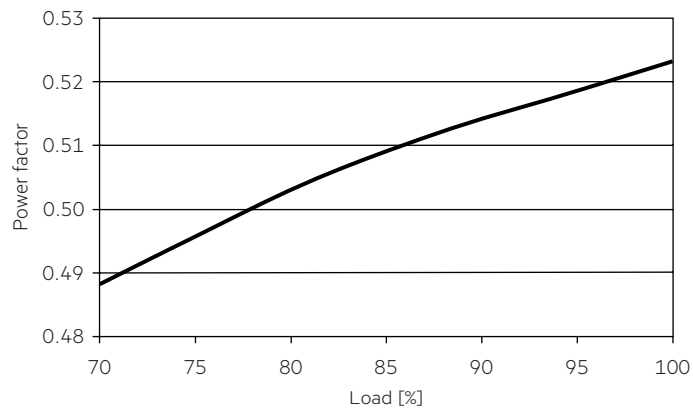

4.1.5 THD vs load

THD without harmonic < 5 mA (0.6 %) of the input current:

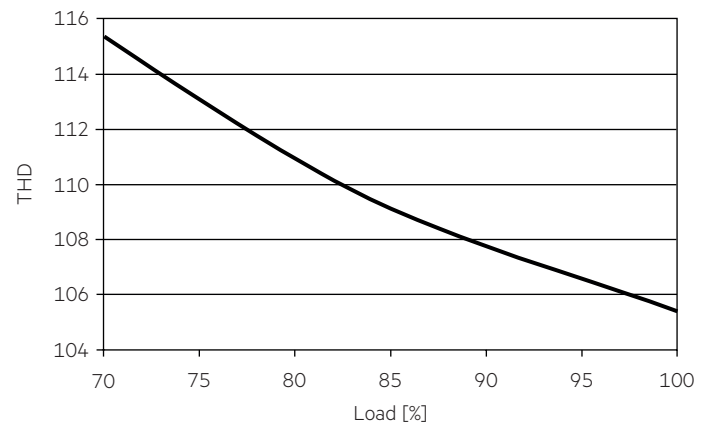

4.1.3 Input power vs load

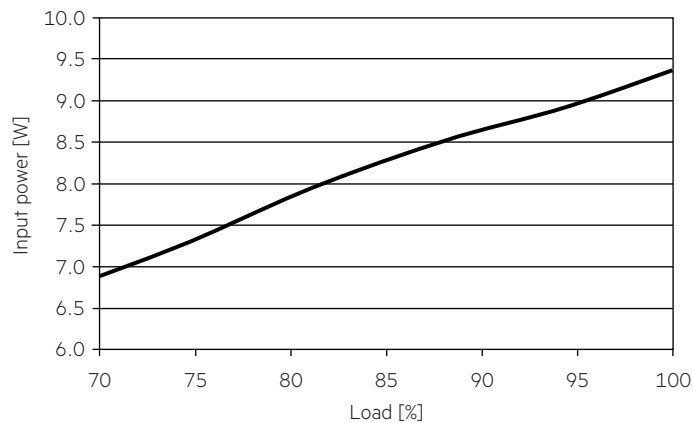

4.2 Diagrams LC 8W 200mA fixC SR SNC2

4.2.1 Efficiency vs load

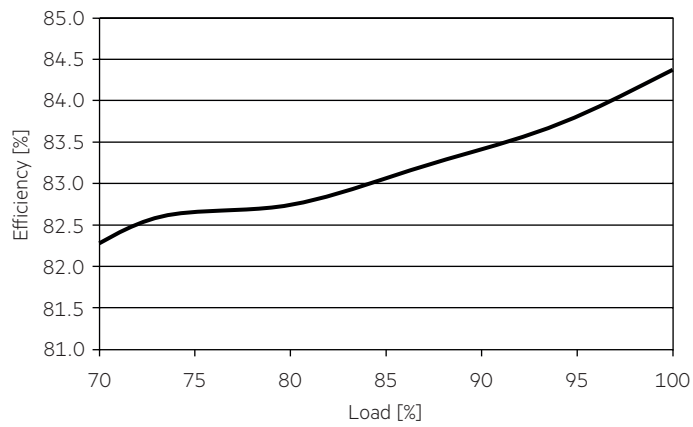

4.2.4 Input current vs load

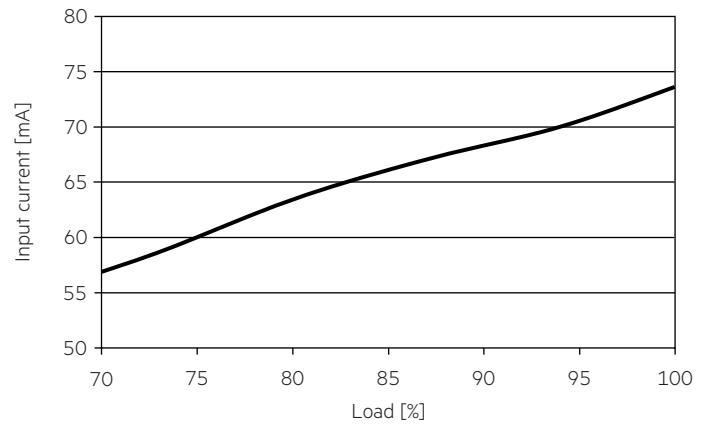

4.2.2 Power factor vs load

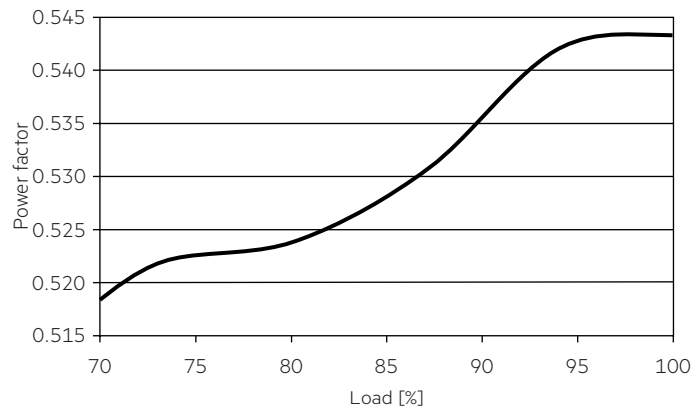

4.2.5 THD vs load

THD without harmonic < 5 mA (0.6 %) of the input current:

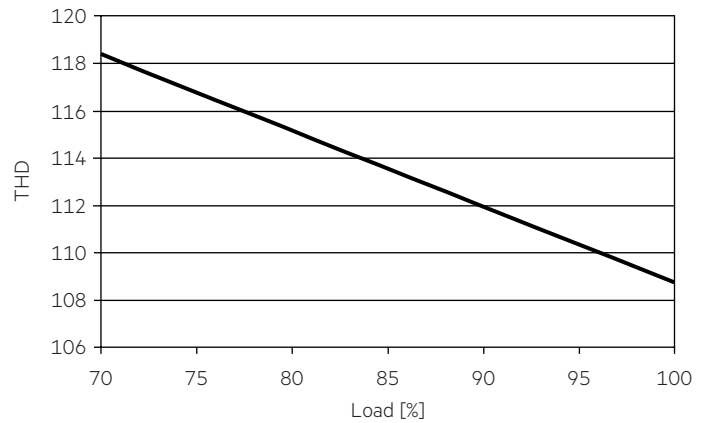

4.2.3 Input power vs load

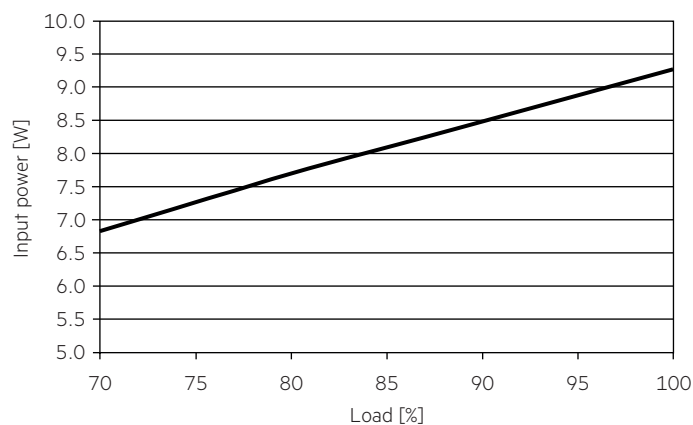

### 4.3 Maximum loading of automatic circuit breakers in relation to inrush current

#### Maximum loading of automatic circuit breakers

Automatic circuit breaker type	C10	C13	C16	C20	B10	B13	B16	B20	Inrush current	
									$I_{max}$	Time
Installation $\emptyset$	1.5 mm <sup>2</sup>	1.5 mm <sup>2</sup>	2.5 mm <sup>2</sup>	2.5 mm <sup>2</sup>	1.5 mm <sup>2</sup>	1.5 mm <sup>2</sup>	2.5 mm <sup>2</sup>	2.5 mm <sup>2</sup>		
<b>LC 8/180/44 fixC SR SNC2</b>	92	115	138	170	55	69	83	102	10 A	115 $\mu$ s
<b>LC 8/200/40 fixC SR SNC2</b>	92	115	138	170	55	69	83	102	10 A	115 $\mu$ s

These are max. values calculated out of inrush current! Please consider not to exceed the maximum rated continuous current of the circuit breaker. Calculation uses typical values from ABB series S200 as a reference. Actual values may differ due to used circuit breaker types and installation environment.

### 4.4 Harmonic distortion in the mains supply (at 230 V / 50 Hz and full load) in %

	THD	3.	5.	7.	9.	11.
<b>LC 8/180/44 fixC SR SNC2</b>	< 120	< 80	< 55	< 40	< 30	< 30
<b>LC 8/200/40 fixC SR SNC2</b>	< 120	< 80	< 55	< 40	< 30	< 30

Acc. to 61000-3-2. Harmonics < 5 mA or < 0.6 % (whatever is greater) of the input current are not considered for calculation of THD.

## 5. Functions

### 5.1 Short-circuit behaviour

In case of a short circuit on the output side (LED) the LED driver switches off. After elimination of the short-circuit fault LED driver will recover automatically.

### 5.2 No-load operation

The LED driver works in burst working mode to provide a constant output voltage regulation which allows the application to be able to work safely when LED string opens due to a failure.

### 5.3 Overload protection

If the maximum load is exceeded by a defined internal limit, the LED driver will protect itself and LED may flicker. After elimination of the overload the nominal operation will recover automatically.

## 6. Miscellaneous

### 6.1 Insulation and electric strength testing of luminaires

Electronic devices can be damaged by high voltage. This has to be considered during the routine testing of the luminaires in production.

According to IEC 60598-1 Annex Q (informative only!) or ENEC 303-Annex A, each luminaire should be submitted to an insulation test with 500 V<sub>DC</sub> for 1 second. This test voltage should be connected between the interconnected phase and neutral terminals and the earth terminal. The insulation resistance must be at least 2 M $\Omega$ .

As an alternative, IEC 60598-1 Annex Q describes a test of the electrical strength with 1500 V<sub>AC</sub> (or 1.414 x 1500 V<sub>DC</sub>). To avoid damage to the electronic devices this test must not be conducted.

### 6.2 Conditions of use and storage

Humidity: 5 % up to max. 85 %, not condensed (max. 56 days/year at 85 %)

Storage temperature: -40 °C up to max. +80 °C

The devices have to be within the specified temperature range (t<sub>a</sub>) before they can be operated.

### 6.3 Maximum number of switching cycles

All LED driver are tested with 50,000 switching cycles.

### 6.4 Additional information

Additional technical information at [www.tridonic.com](http://www.tridonic.com) → Technical Data

Lifetime declarations are informative and represent no warranty claim. No warranty if device was opened.